

OUTLINER 20 / OUTLINER 40

RECESSED Standard

IP40 / IP66

Installation Guide

OUTLINER 20 Recessed Standard

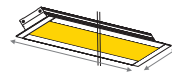
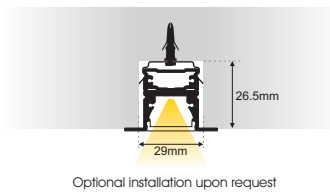
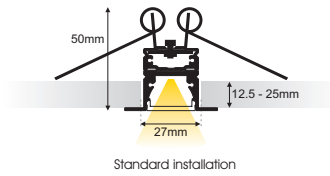
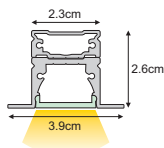

Dimensions:

for Monochromatic, Tunable White:
39x54.6/87.9/ 104.6/121.3/154.6/204.6cm
Cutting Hole:
27x53.6/86.9/103.6/120.3/153.6/203.6cm

for RGBWW-RGBCW 84LED/m:
39x54.6/90.3/ 104.6/126/154.6/204.6cm
Cutting Hole:
27x53.6/89.3/103.6/125/153.6/203.6cm

for RGBWW-RGBCW 60LED/m, RGB 60LED/m, RGB 30LED/m:
39x54.6/84.6/ 104.6/124.6/154.6/204.6cm
Cutting Hole:
27x53.6/83.6/103.6/123.6/153.6/203.6cm

for RGB 96LED/m:
39x54.6/92.1/ 104.6/123.3/154.6/204.6cm
Cutting Hole:
27x53.6/81.1/103.6/122.3/153.6/203.6cm



Note:
Cutting hole must be 10mm shorter than the luminaire length.

OUTLINER 40 Recessed Standard

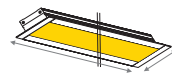
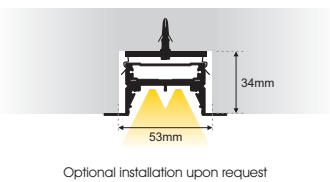
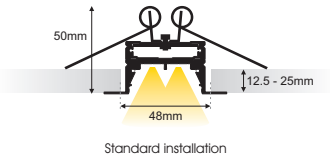
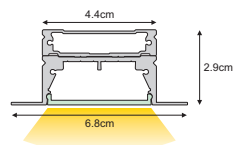
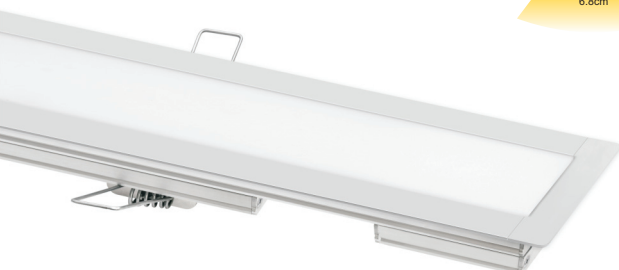

Dimensions:

for Monochromatic, Tunable White:
68 x 55.6/88.9/105.6/122.3/155.6/205.6cm
Cutting hole:
48 x 53.6/86.9/103.6/120.3/153.6/203.6cm

for RGBWW-RGBCW 84LED/m:
68 x 55.6/91.3/105.6/127/155.6/205.6cm
Cutting hole:
48 x 53.6/89.3/103.6/125/153.6/203.6cm

for RGBWW-RGBCW 60LED/m, RGB 60LED/m, RGB 30LED/m:
68 x 55.6/85.6/105.6/125.6/155.6/205.6cm
Cutting hole:
48 x 53.6/83.6/103.6/123.6/153.6/203.6cm

for RGB 96LED/m:
68 x 55.6/93.1/105.6/124.3/155.6/205.6cm
Cutting hole:
48 x 53.6/91.1/103.6/122.3/153.6/203.6cm



Note:
Cutting hole must be 20mm than the luminaire length.

1



Attention
Before any maintenance switch off the main power.

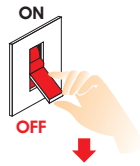

2

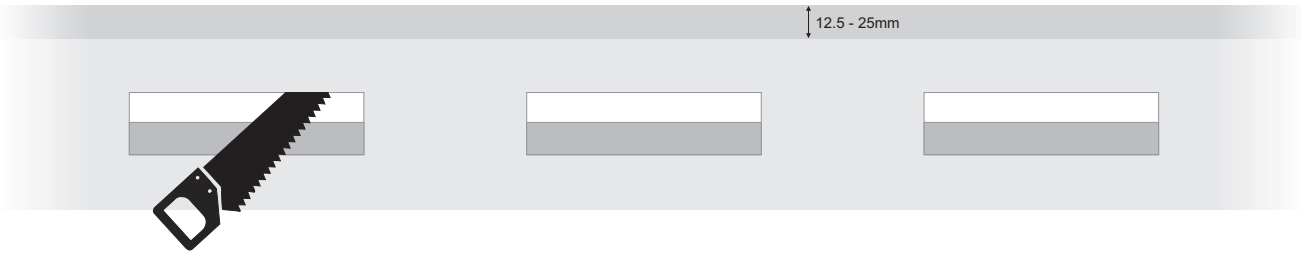

Optional installation with IN-OUT connectors

3

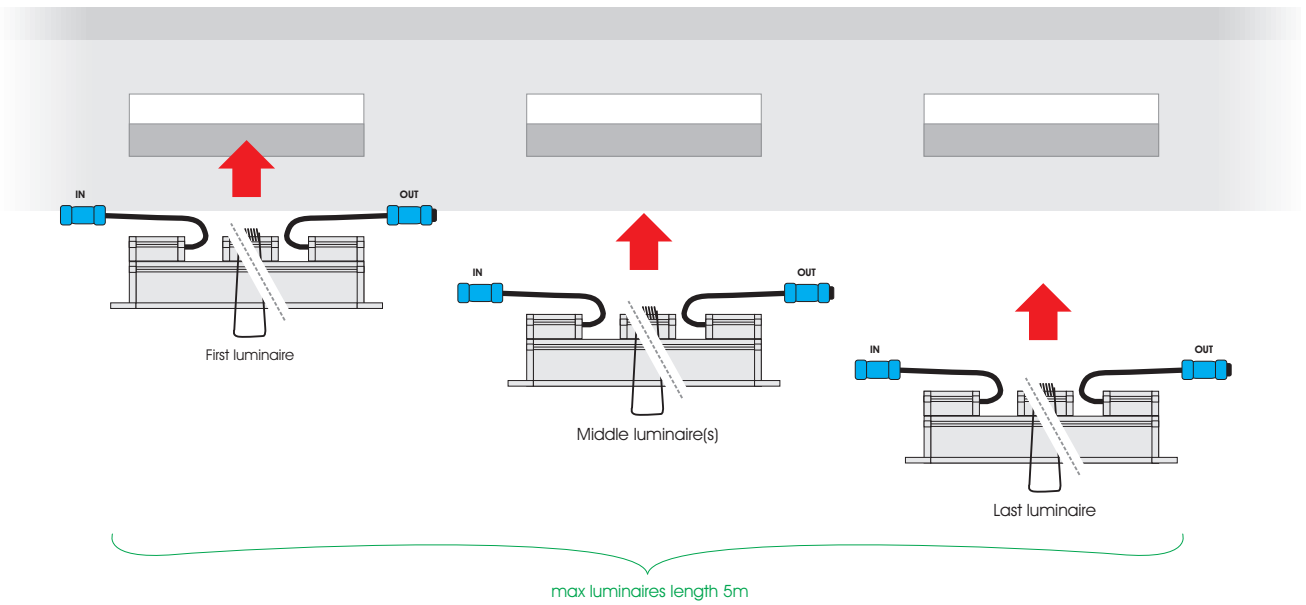

3.1

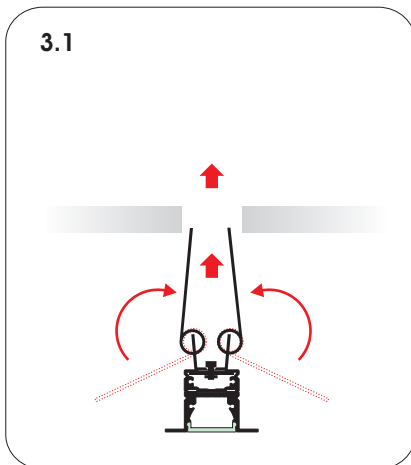

3.2

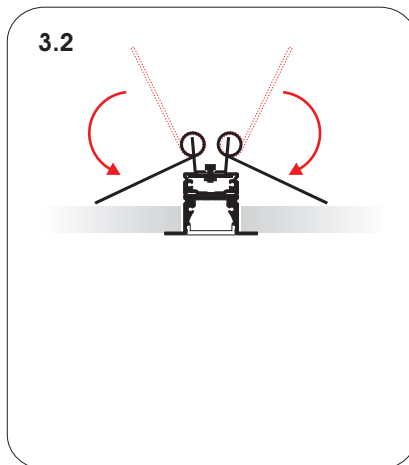

4

Optional installation with IN-OUT connectors

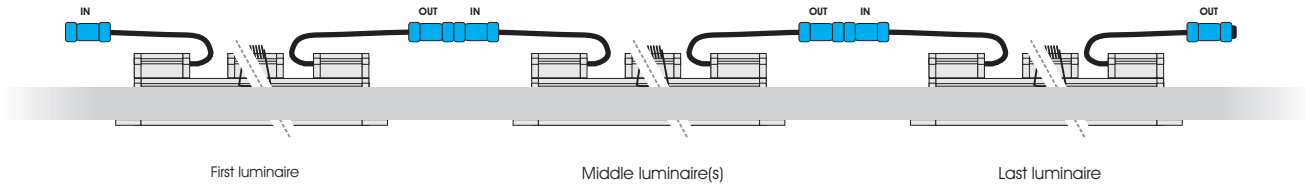

5

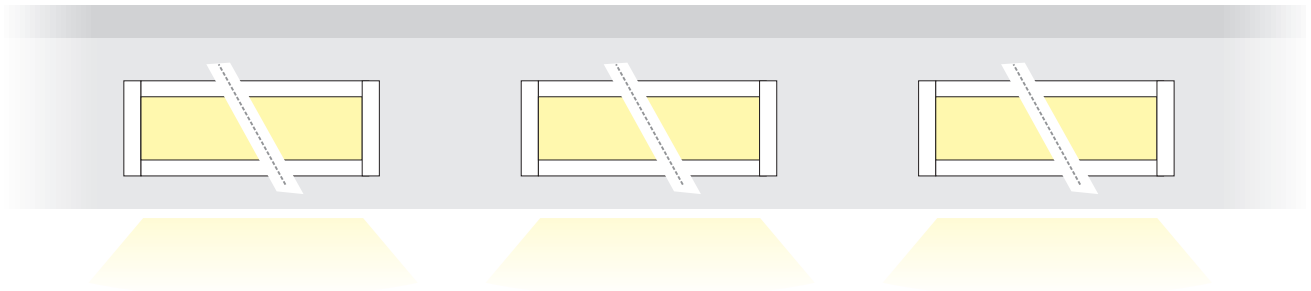
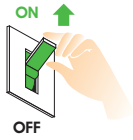

IP Connectors Preparation Guide

Waterproof

Assembling and soldering process for the power plugs.

For assembling and soldering the 2 poles power plugs to the proper cable (same for 3p 4p and 5p cable), the following procedure must be followed in order to be ensured the correct soldering of the cables and the impermeability of the plugs to water.



Attention

This procedure is very important. Thus, if is not completed correctly, there is chance of water leakage through the plugs inside luminaire.

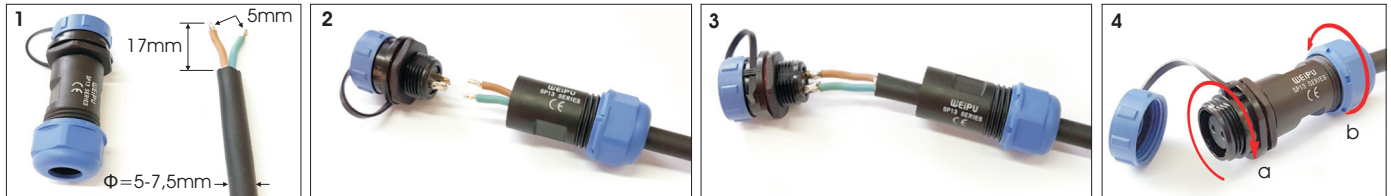

Picture 1. The cable that will be used need to have outer diameter 5-7,5mm. Remove the outer cable insulation by 17mm (maximum) and then remove the two inner insulations from the cables by exact 5mm.

Picture 2. Unscrew the front side from the plug. Insert the cable to the main body of the plug from cable gland's side. Galvanize cable's copper and terminals inside the plug.

Picture 3. Solder the cables to the plug's terminals.

Picture 4a. Screw and well tighten the side of the terminals to the main body. In order for strong tightening to be achieved, connect the plug to its corresponding male or female pair and repeat the previous procedure.

Picture 4b. Cable's gland has to be strongly tightened.

Cables and power connectors description.

Luminaire is delivered with or without power connectors. When connectors are not available the cables will have color coding as mentioned in the parentheses. When connectors are available each pole has a numeric description. In the brackets below you can find the number as it is marked on each cable.

Monochromatic Models.

Male 2p. Female 2p.

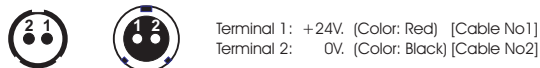

Tunable white (Warm-Cool) Models.

Male 3p. Female 3p.

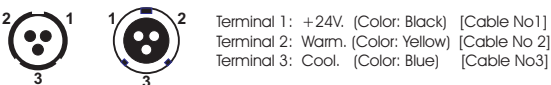

Tunable white (Warm-Neutral-Cool) Models.

Male 4p. Female 4p.

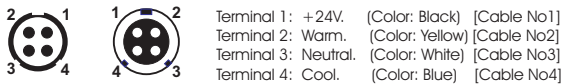

RGB Models.

Male 4p. Female 4p.

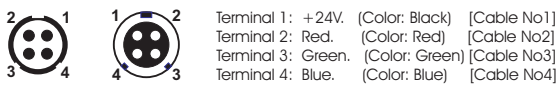

RGBW Models.

Male 5p. Female 5p.

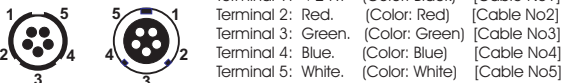

OUTLINER 20/40 RC IP40/IP66	Maximum lenght of OUTLINER daisy chain.
Monochromatic.	5m
RGB.	5m
RGBW.	5m

Note:

In daisy chains it is possible for the luminosity of the first OUTLINER to be different with luminosity of the last one. This might happen because of the voltage drop due to the resistance from the supply cable. In order to avoid this you can also supply the output of the last OUTLINER from the same power supply.

Please also make sure that the cross section of the cable from the power supply or controller to the two ends of the connected OUTLINER daisy chain is the same.